

Voice Module AF-MUL

User Manual

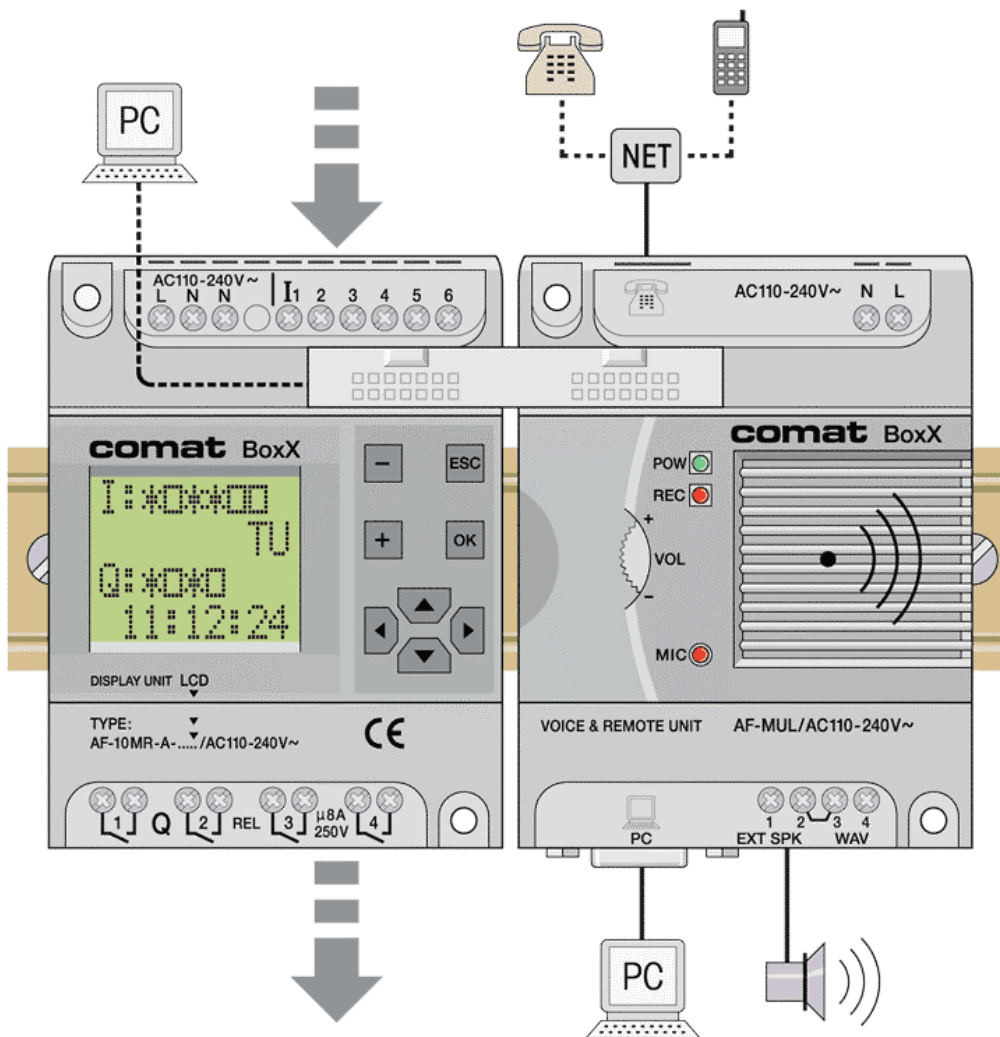
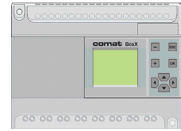



Table of contents

Introduction	3
1.1 Structure of Voice Module AF-MUL.....	3
1.2 Connection between Comat BoxX and AF-MUL	4
Programming of AF-MUL.....	5
2.1 Assigned functions	6
2.2 Recording via WAV input with a PC	7
2.2.1 Configuration	7
2.2.2 Selection of max. recording time.....	8
2.2.3 Online Recording	9
2.2.4 Set Ring repetitions	10
2.2.5 Password for outgoing calls	11
2.2.6 Acceptance of incoming calls.....	12
Playing of messages	14
3.1 PLAY Function Block.....	14
3.2 Function description of PLAY Function Block.....	14
Automatic dial function	16
4.1 TEL and RS Function Blocks.....	16
4.2 Function description of TEL and RS Function Blocks.....	17
4.3 Application of the automatic dialing function.....	18
4.4 Hang up and open phone line	18
Application example.....	19
Recording of messages via the incorporated microphone	22
6.1 Function Block MR.....	22
6.2 Temporary installation of one switch for recording	22
6.3 Deleting all previous recordings.....	23
6.4 Recording	23
6.5 Recording example.....	24
6.6 Recording of voice messages via WAV input with a tape recorder	25



Chapter I

Introduction

Interlinking the Comat BoxX with the Voice Module AF-MUL allows several additional functions and features:

- a) Playing of voice messages (for example alarm alerts) via the incorporated AF-MUL speaker.
- b) Playing of voice messages over an additional external loud speaker.
- c) Dialling up of a telephone number over the phone network and playing voice messages.
- d) Receiving calls and control signals over the phone network.

This functions allows an additional wide field of applications of remote alarm and status transmissions, as well as remote controlling of the Comat BoxX by phone (mobile phones) touch keys.

The Voice Module AF-MUL has to be connected to the Comat BoxX with a special bridge connector AF-BC (Included with AF-MUL).

1.1 Structure of Voice Module AF-MUL

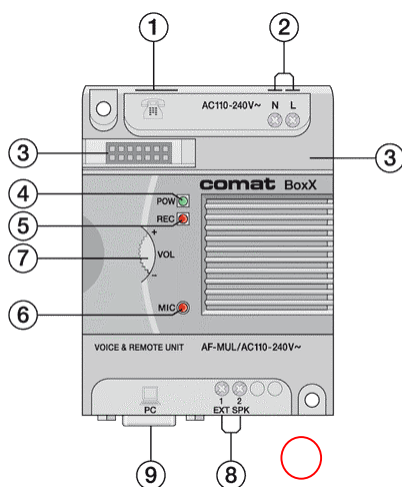

Fig. 1.1

1. Socket for telephone line (plug type...)
2. Power supply terminals(110-240VAC; 12-24VDC)
3. Connecting Port with Comat BoxX (with enclosed plug AF-BC)
4. Power indication
5. Recording indication
6. Recording Microphone
7. Volume of AF-MUL Speaker
8. Terminal (port) for external Active speaker
9. Communication Port: Computer connection to monitor or program Comat BoxX, or Modem.
Connection via AF-M232 cable.
Use cable AF-RS232 to remote monitor Comat BoxX via AF-MUL with a PC.
10. WAV input connection



1.2 Connection between Comat BoxX and AF-MUL

- The AF-MUL module is snapped onto DIN-rail together with a Comat BoxX. [Pos. 3]
- Connect Comat BoxX and AF-MUL with the special connection bridge AF-BC (enclosed with the AF-MUL voice module). [Pos. 1]
- Connect the power supply of AF-MUL and Comat BoxX first and plug the telephone line into the “TEL” socket (110-240VAC or 12-24VDC). [Pos2]

Pin allocation RJ12

Pin1 -	A
Pin2 -	B
Pin3 -	A
Pin4 -	B
Pin5 -	A
Pin6 -	B

Fig. 1.2



Note:

Before recording the voice message the Comat BoxX and the AF-MUL must be programmed and configured. Therefore use a PC and the programming software Quick II. Connect PC with AF-MUL using the connection cable AF-RS232.

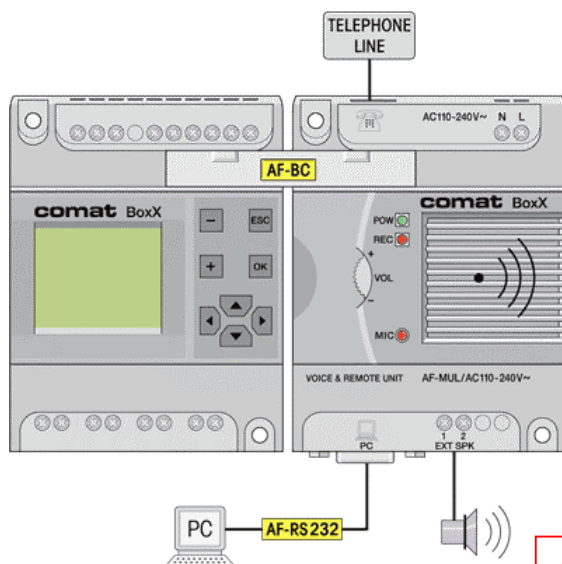
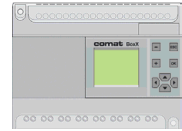

Fig. 1.3

AF-ATL
WAV-Input



Chapter II

Programming of AF-MUL



Note:

Recordings must be done before BoxX programming with the LCD programming keys.

The function principle is similar to a recording with a tape recorder.

The different messages are recorded in sequence and one after the other i.g. the first recording automatically is stored as message number 0, the second recording as message number 1, the third recording as message number 2, and so on.

Recording options:

1. Directly over the incorporated AF-MUL microphone (Pos. 6)
2. Over the WAV input (Pos. 10)
 - a) Connecting a tape recorder
 - b) Connecting a PC or a note book and recording with the PC or note book microphone
 - c) Data transfer of a synthetic voice from the PC.



Please note:

Special functions are assigned for the first 4 recordings.

It is not possible to change these assignments and message numbers.



2.1 Assigned functions

Message No.	Function	Example
0	Welcome message when answering a call.	Thank you for your call. Please enter your password.
1	Confirmation of the right password.	The password is correct. Please enter your control code.
2	Wrong password information.	The password is wrong. Please try again.
3	Greeting of a called up subscriber.	Hello. This is your Comat BoxX. Please enter your password.

Telephone call

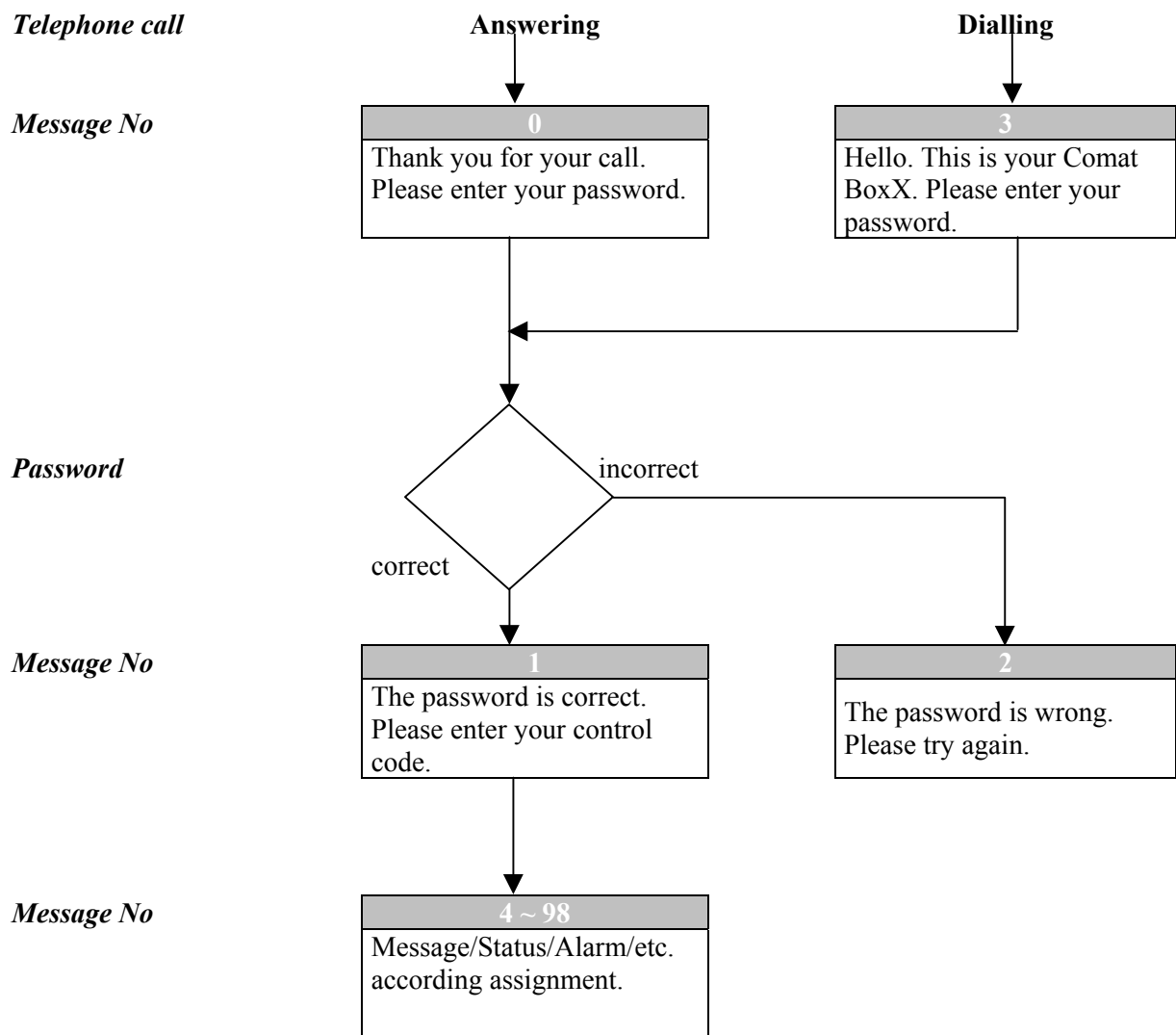

All further messages (4 ~ 98) can be assigned to any functions, status or alarm messages.

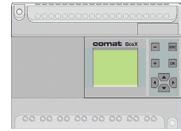

2.2 Recording via WAV input with a PC

The Windows operating system includes an Audio recorder. The Audio recorder allows recording and playing of WAV files.

You may find the Audio recorder under the path:
Programs/Accessories/Entertainment Media's/Audio Recorder.

A WAV file is requested for each message

Example:

Message 0 = Message 0.WAV

Message 1 = Message 1.WAV

It is also possible to create and record a synthetic WAV voice with the PC

Suitable software may be found under: www.logox.de.

This software allows to enter a written Text message with a synthetic voice playback.

2.2.1 Configuration

1. Connect WAV cable (AF-WAV) to the WAV input of the AF-MUL (Pos. 10)
2. Connect the programming cable (AF-RS-232) between the AF-MUL (Pos. 9) and your PC
3. Connect power supply to AF-MUL.
(110-240VAC or 12-24VDC, Pos. 2)

Click „Option“ and select your COM-Port. Confirm with OK.

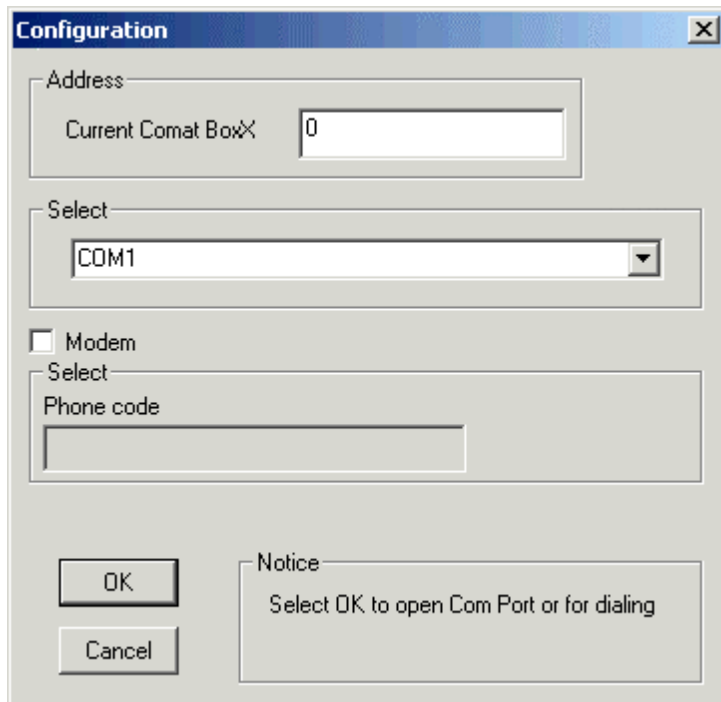

Fig. 1.4



2.2.2 Selection of max. recording time

Select „Set Voice Module Type“.

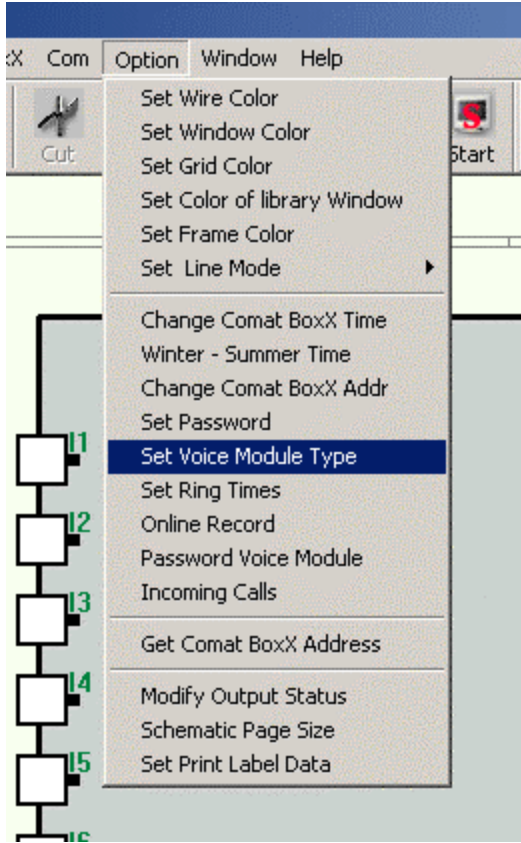

Fig. 1.5

Set Voice length type

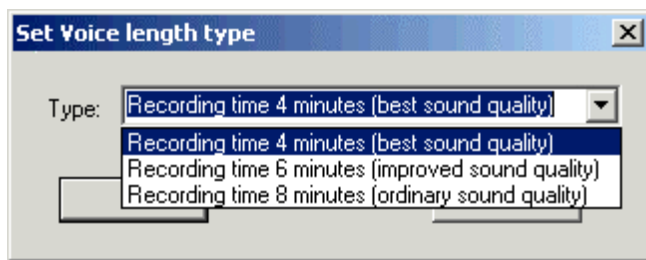
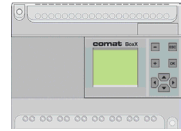

Fig. 1.6



Remark:

Shorter recording time results in improved voice quality.



2.2.3 Online Recording

Select „Online Record“ from the Option menu.

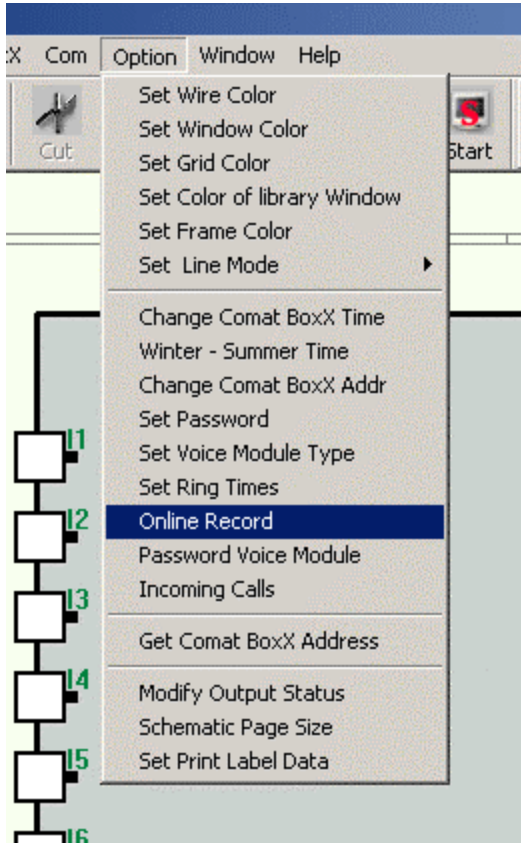
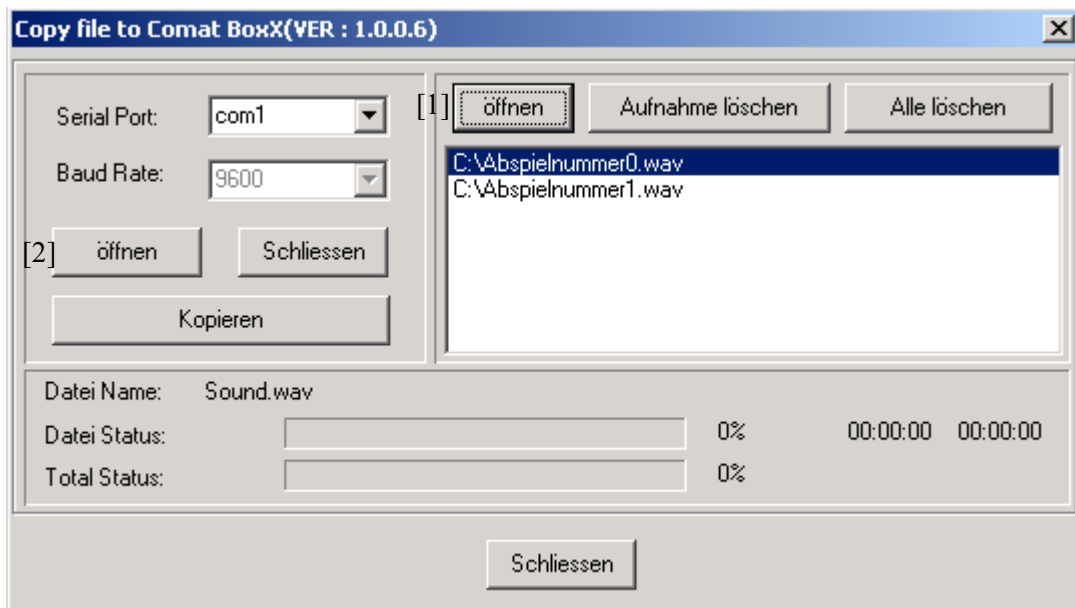

Fig. 1.7

The following window opens:



Platzhalter
er
Fig. 1.8



Note:

The first file is assigned automatically as message number 0, the second file is assigned message number 1, etc.

Open Com port first to prepare the BoxX for message transfer.

The Baud rate is preset to 9600 and should not be altered.

Use „Start Copy“ to transfer the messages into the AF-MUL.

Each message is replayed after transmission is completed.

Exit with „Close“.

2.2.4 Set Ring repetitions

This window allows to choose repetitions of calling rings before the AF-MUL answers a phone call.

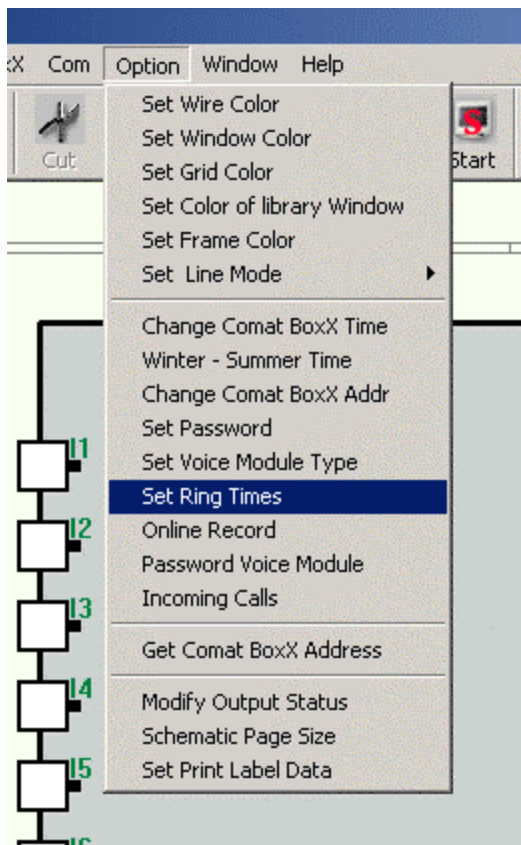
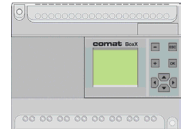

Fig. 1.9



Select between 1 to 10 ring repetitions.

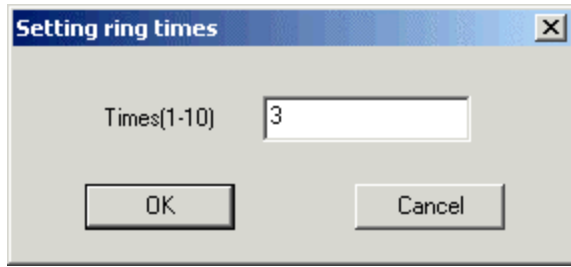

Fig. 1.10

2.2.5 Password for outgoing calls

This setting is used to transmit messages by outgoing calls without prior request for password entering i.e. the receiver of the call will receive an alarm message by answering the call and without entering a password to listen to the message.

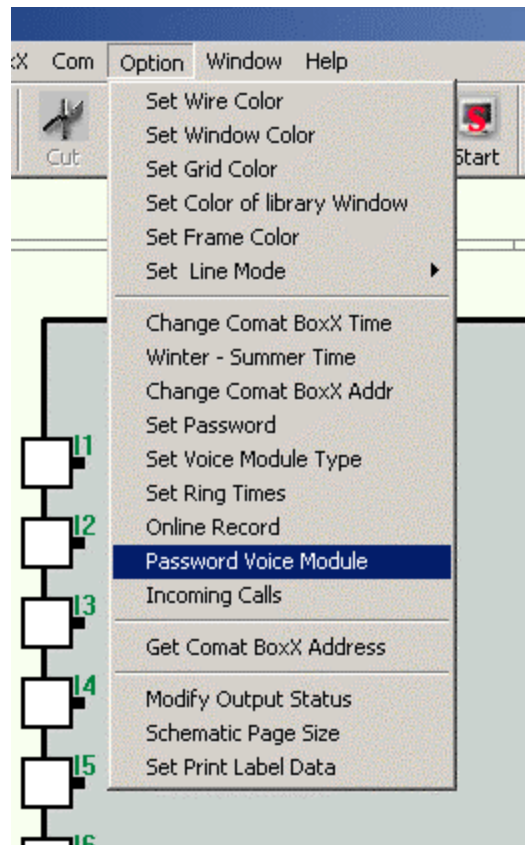

Fig. 1.11

If Yes is selected, the AF-MUL request the password before the message is played.

If No is selected, the AF-MUL plays the message without asking for the correct password.

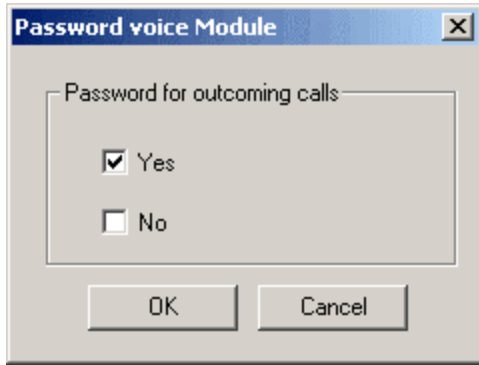

Fig. 1.12

2.2.6 Acceptance of incoming calls

This feature allows to ignore incoming calls.

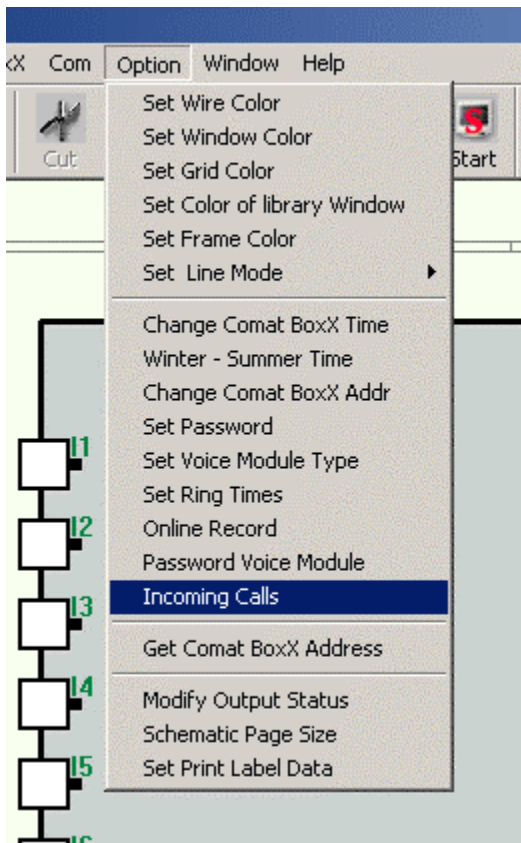

Fig. 1.13

If No is selected, no incoming calls are accepted.

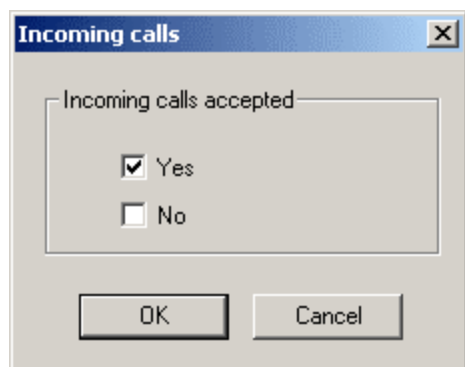
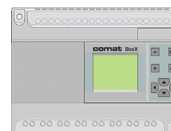

Fig. 1.14



Chapter III

Playing of messages

The Function Block for message broadcasting are available in the library "Special Function Blocks".



Fig. 1.15

3.1 PLAY Function Block

Function	Representation	Function block
PLAY (Message playing block)		

3.2 Function description of PLAY Function Block

Comat BoxX Symbol	Signal	Description
	ON	When ON is „1“, Output Q is „1“, i.e. the voice section is turned on for broadcasting. The option range for its input is I1 – I12, Q1 – Q8, HI, LO, M00 – M126, X.
	OFF	When OFF is „1“, Output Q is „0“, i.e. the voice section is turned off. The option range of its input is I1 – I12, Q1 – Q8, HI, LO, M00 – M126, X.
	Output Q	The option range of output is 01 – 98, and there are 98 voice sections in total.

Application:

This function is applicable where voice prompt is required.

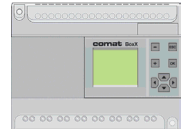

Sample to control the Play Function Block:

If the Input is „1“ the message is continuously played until the input is reset.

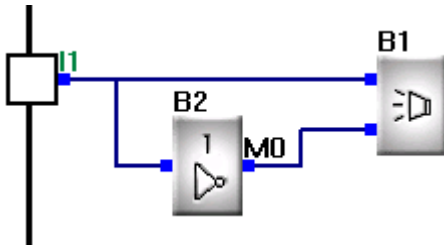

Fig. 1.16



Note:

If two different playing blocks are called at the same time to play a message, the message of the Function Block with the higher block number will be played.



Chapter IV

Automatic dial function

The Comat BoxX can automatically dial via the AF-MUL Voice Module and transmit alarm alerts.



Fig. 1.17

You need the TEL phone dialling and RS Set-/Reset Function Blocks to call other subscribers and to transmit messages or alerts.

4.1 TEL and RS Function Blocks

Function	Representation	Function block
RS (Set relay / Reset relay)		
TEL (Telephone dialling block)		



Note:

The function of the telephone block is for dialling out, receiving calls, receiving control signals or send out voice messages (alarms). (*key + number).

This block is used together with the locking-up relay (RS relay) function block.

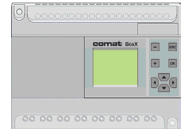

4.2 Function description of TEL and RS Function Blocks

TEL Function block

Comat BoxX Symbol	Signal	Description
	Input	Following Inputs can be selected: Input I1 up to I12 Output Q1 up to Q8 Status = High (H = "1") Status = Low (L = "0") Intermediate relay M00 up to M126 Telephone keys P0 up to P9
	Output	When Q is „1“, the programmed telephone number of this port will be dialled. If the input has been „1“ all the time, dialling will be repeated every 30 seconds. When the input is „0“, dialling stops. The output port accepts telephone numbers of max. 25 digits.

RS Set-/Resetrelay

Comat BoxX Symbol	Signal	Description
	Input S	Output Q is set to „1“ by Input S (Set 1 pulse is sufficient). S port can receive two-tone signal input such as P0 – P9 phone signals.
	Input R	Output Q is set to „0“ by Input R (Reset). If S and R are „1“ at the same time, the Output Q is „0“. R has priority over S.
	Output Q	When S is „1“, Q is ON („1“) and held ON, and will not be reset until Input R is set („1“).

Switch characteristics

RS relay is a simple trigger.

The output value depends on the input status and the original output status.



The following list of true values is used to describe the logic relations:

S	R	Q	Remark
0	0		Status remains to the original value
0	1	0	Reset
1	0	1	Set
1	1	0	Reset having priority over Set



Note:

P0 – P9 represent the 0 – 9 buttons of the telephone keys. The RS block can receive two-tone telephone signals (Mobile phone) and can be used for remote controlling the Comat BoxX (* key + number).

4.3 Application of the automatic dialing function

Connect the AF-MUL with the Comat BoxX and connect the power supply. Switch ON power and programme the TEL Function Block as shown below. (Programming Manual Chapter 5.7.3)

Example:

Automatic dialling of phone number 031xxxxxxx:

Double click TEL Function Block and enter the number 031xxxxxxx into window „Phone Code“.

The phone number will be automatically dialled if Input I1 has status „1“.

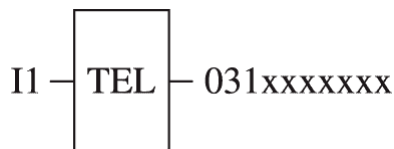
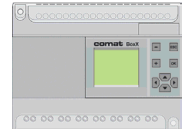

Fig. 1.18

4.4 Hang up and open phone line

- If the AF-MUL is called up by an external phone, it takes 1 minute for the voice module to hang up after the phone line has been cleared.
- If the AF-MUL calls another subscriber which does not enter the correct password, the AF-MUL hangs up after 1 minute and clears the line.
- If the AF-MUL calls up a subscriber which does not answer the call, the AF-MUL hangs up after 1 minute and clears the line for 30 seconds before the call to the subscriber is repeated for another minute.
- If the AF-MUL calls up a subscriber which enters the correct password, however does not enter a control code, the call is interrupted after 1 minute and the line will be cleared.
- If the AF-MUL answers an incoming call (password accepted) and after a control code has been entered by the subscriber, the AF-MUL hangs up automatically and clears the line after 90 seconds.



Chapter V

Application example

- Remote switch ON and OFF of a heating appliance via the phone.
- Monitoring of motion sensor.
- Transmit alarm message „Burglar in the house“ over the telephone line (External Phone number 031354876)
- Play „Burglar in the house“ over the incorporated AF-MUL speaker
- Switch ON of alarm siren
- Switch OFF alarm
- Switch ON alarm

The following recordings/messages are required. (Chapter 1.3)

Message No.	Function	Recording / Playing
0	Welcome message when answering a call.	Thank you for your call. Please enter your password.
1	Confirmation of the right password.	The password is correct. Please enter your control code.
2	Wrong password information.	The password is wrong. Please try again.
3	Greeting of a called up subscriber.	Hello. This is your Comat BoxX. Please enter your password.
4	Heater ON.	The heater is on.
5	Heater OFF.	The heater is off.
6	Alarm alert.	Burglar in the house.
7	Alarm ON.	Alarm is on.
8	Alarm OFF.	Alarm is off.



Program the following circuit

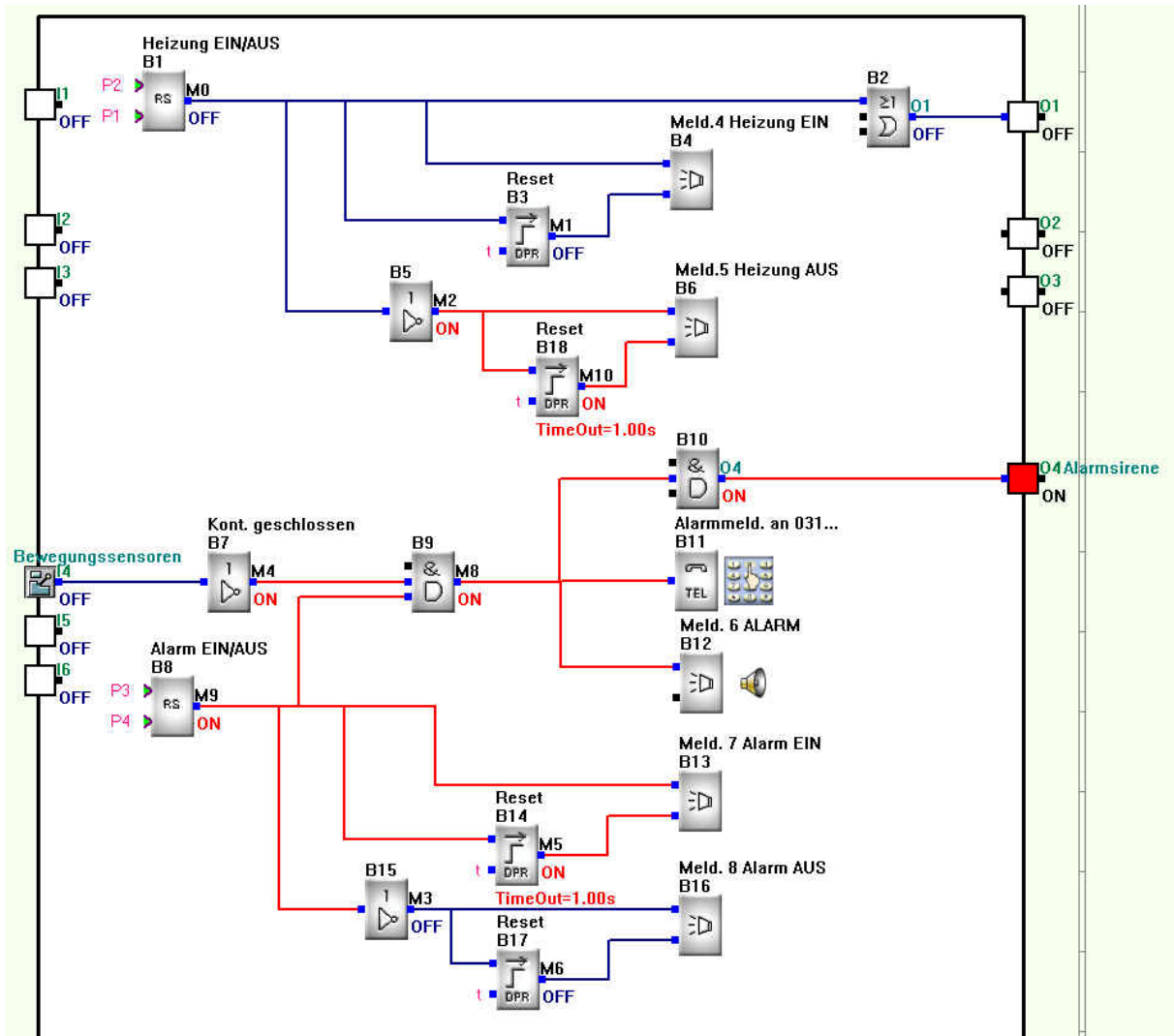
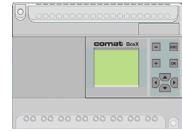

Fig. 1.19 **Englisches Program verwenden!!!!**

Record the 8 messages as described on previous pages (Item 5).

You have now programmed the following functions:

- After dialling the MUL phone number, you will hear message number 0.
„Thank you for your call. Please enter your password.“
- Use the phone touch down keys to enter your password.
If the password is wrong, message 2 will be played.
„The password is wrong. Please try again.“
If the entered password is correct, you will hear message 1.
„The password is correct. Please enter your control code.“
- Use phone key1 to switch on the heater. At the same time message 4 will be played.
„The heater is on.“



- Use phone key2 to switch off the heater. At the same time message 5 will be played.
„The heater is off.“
- The AF-MUL automatically dials the phone number 031354876 if the circuit of the motion sensor is interrupted.
You will hear message 3
„Hello. This is your Comat BoxX. Please enter your password.“
- Use the phone touch keys to enter your password.
If the password is wrong, message 2 will be played.
„The password is wrong. Please try again.“
If the entered password is correct you will hear message 1.
„The password is correct. Please enter your control code.“
- You will now hear message 6.
“ Burglar in the house.”
- The alarm is deactivated with phone key 4. Message 8 is played for your confirmation.
„Alarm is off.“
- If you call the AF-MUL phone number, the MUL is answering your call with message 0.
„Thank you for your call. Please enter your password.“
- Use the phone touch keys to enter your password.
If the password is wrong message 2 will be played.
„The password is wrong. Please try again.“
If the entered password is correct, you will hear message 1.
„The password is correct. Please enter your control code.“
- The alarm is switched on with phone key 4 and off with phone key 3.
Your control signal will be confirmed accordingly with message 7 or 8.



Note:

Each control number has to start with a „*“.
For example: *4.



Chapter VI

Recording of messages via the incorporated microphone

6.1 Function Block MR

Function Block MR is required for recording a message.

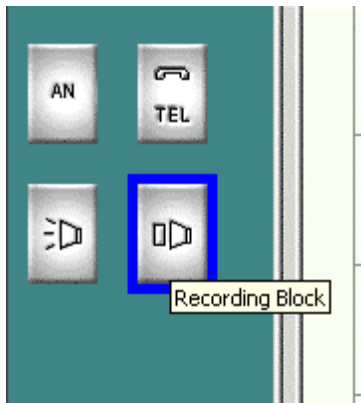

Fig. 1.20

6.2 Temporary installation of one switch for recording

1. Connect AF-MUL with Comat BoxX (AF-BC) and connect to power supply.
2. Connect to temporary switch (k1) between power supply input L and signal input I1 as shown in fig. 1.21.

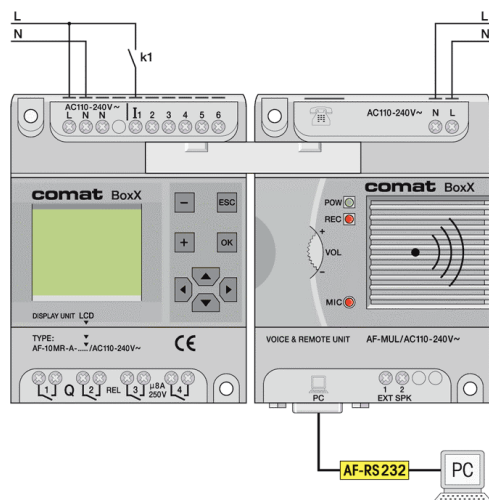
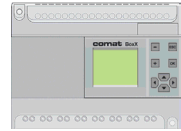

Fig. 1.21



3. Switch the power supply on and program the following circuit:

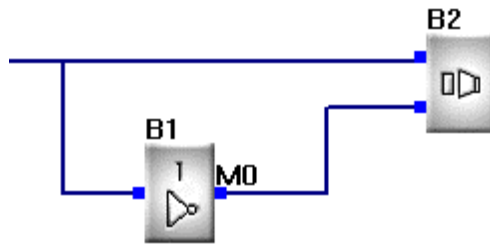

Fig. 1.22



Note:

Only one recording block allowed per programming circuit.



Attention:

Code 99 deletes all previous recordings.
Code 00 starts recording with message 0.

6.3 Deleting all previous recordings

Set Code 99 on Recording Function Block MR.
Close switch k1 for one second and open switch again.
The memory of AF-MUL is now empty (all previous messages are erased).

6.4 Recording

Set code 0 on Recording Function Block.
Close switch k1.
The red lamp [Pos. 5, Fig. 1.1] will be illuminated and indicates that recording is in progress.
Speak your message into the AF-MUL microphone [Pos. 6; Fig. 1.1].
Open switch k1 after your message is completely recorded.
The recorded message will be played back.



Note:

The first recording is automatically assigned as message number 0.
(Refer to [chapter 2.1](#) Assigned functions)

Closing switch k1 again starts the next recording.
The red lamp [Pos. 5, Fig. 1.1] will be illuminated and indicates again that recording is in progress.
Speak your second message into the AF-MUL microphone [Pos. 6; Fig. 1.1].
Open switch k1 after your second message is completely recorded.
The recorded message is played and is assigned to message number 1.
Repeat the same procedure until all Messages are recorded.



Note:

Messages are automatically assigned to message number in the recording sequence. i.e. first recording to message number 0, second recording to message number 1, etc. etc.
It is not possible to record message number 5 before recording number 4.
Recordings can not be corrected once they are recorded. Single messages can only be selected for play back but not for recording.

Recommendation:

Set the recording time to max. 4 minutes to receive a better voice quality. (Refer to [chapter 2.2.2](#)).
To avoid feedback turn the volume switch on the AF-MUL to minimum volume.

6.5 Recording example

1. Close switch k1.
The red lamp [Pos. 5, Fig. 1.1] is illuminated and indicates that recording is in progress.
Record message:
„Thank you for your call. Please enter your password.“
Open switch k1.
The microphone is off and your recorded message is replayed.
This recording is assigned message number 0.
2. Close switch k1.
The red lamp [Pos. 5, Fig. 1.1] is illuminated and indicates that recording is in progress.
Record message:
„The password is correct. Please enter your control code.“
Open switch k1.
The microphone is off and your recorded message is played back.
This recording is assigned message number 2.
3. Close switch k1.
The red lamp [Pos. 5, Fig. 1.1] is illuminated and indicates that recording is in progress.
Record message:
„The password is wrong. Please try again.“
Open switch k1.
The microphone is off and your recorded message is played.
This recording receives message number 2.
4. Close switch k1.
The red lamp [Pos5, Fig. 1.1] is illuminated and indicates that recording is in progress.
Record message:
„Hello. This is your Comat BoxX. Please enter your password.“
Open switch k1.
The microphone is off and your recorded message is played back.
This recording is assigned message number 3.
5. Repeat the above recording procedure until all messages have been recorded.
Max. messages/recordings = 99.

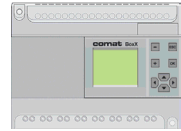

6.6 Recording of voice messages via WAV input with a tape recorder

The procedure is the same as described above.

At the same time play switch on the tape recorder k1 should be depressed.

Opening switch k1 ends the recording.